

Author(s) Heiko Gschwind
Restrictions Public Document
Abstract This application note describes the use of extended signal multiplexors in DBC databases.

Table of Contents

1.0	Overview	2
2.0	What is Extended Signal Multiplexing?.....	2
2.1	Simple Signal Multiplexing	2
2.2	Extended Signal Multiplexing	3
3.0	Tools Supporting Extended Multiplexing	4
4.0	Extended Multiplexing in CANdb++ and CANdb++ Admin.....	4
4.1	Boundary Conditions	4
4.2	Set Up for Extended Signal Multiplexing.....	5
5.0	Extended Multiplexing in CANoe and CANalyzer.....	8
5.1	Interactive Generator Block.....	8
5.2	Trace Window	9
5.3	Data Window	10
6.0	Additional resources	11
7.0	Contacts	11

1.0 Overview

In a DBC database **Messages** and **Signals** can be defined. Signals represent the smallest unit of information. They can be transmitted in a message via a bus. A signal that is linked to a message is referred to as a **Message Signal**. The signal's position within the message is specified by indicating the start bit. Using **Signal Multiplexing** different signals can be transmitted in a message depending on a multiplex value.

For the J1939 protocol in the DBC database, a **Parameter Group** is equivalent to a message and a **Parameter** is equivalent to a signal.

2.0 What is Extended Signal Multiplexing?

When describing multiplexing in a DBC database this refers to the multiplexing of signals within a *single* message. The message signals that are transmitted and which depend on the multiplex value are referred to as **Multiplexed Signals**. The signal that contains the multiplexor value is referred to as the **Multiplexor Signal**. There are two multiplexing modes: standard and extended multiplexing.

2.1 Simple Signal Multiplexing

For simple multiplexing only one multiplexor signal can be defined in a message. For each multiplexed signal only one multiplexor value can be defined.

In the example below signal S0 is the one and only multiplexor. S1 to S6 are multiplexed signals.

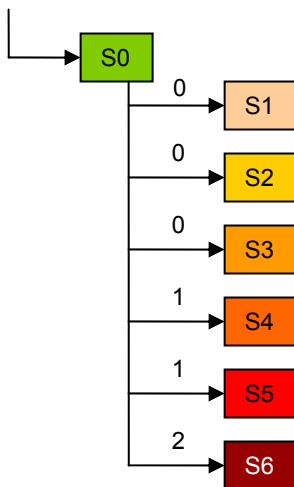

Figure 1 – Signal tree for a message with simple multiplexing

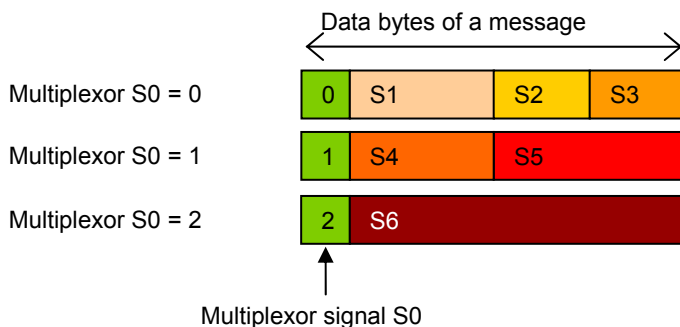

Figure 2 – Message layout for a message with simple multiplexing

2.2 Extended Signal Multiplexing

Extended multiplexing allows defining several multiplexors in a message and a signal can be multiplexed for more than one multiplexor value. A multiplexed signal can also serve as multiplexor signal for other multiplexed signals, meaning that hierarchical multiplexing can be modeled.

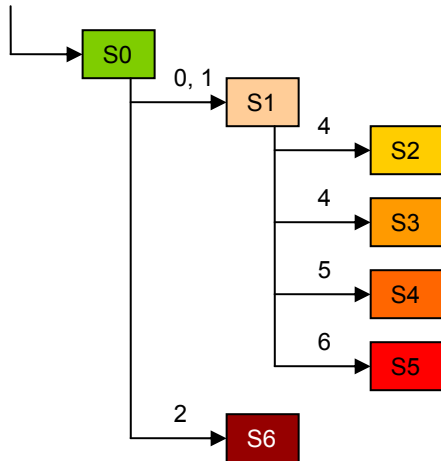

Figure 3 – Signal tree for a message with extended multiplexing

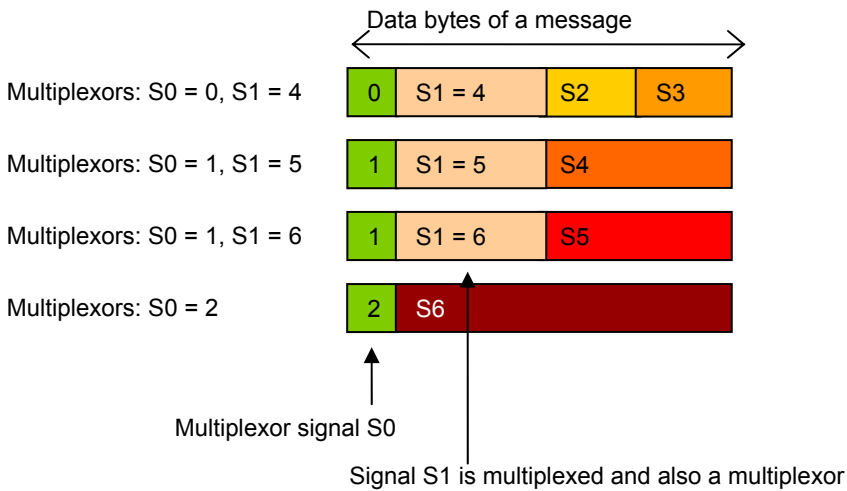

Figure 4 – Several message layout combinations for a message with extended multiplexing

In the example given above (see Figure 3) two multiplexors are defined: Signal S0 and Signal S1. Signal S1 is valid if value of Signal S0 is 0 or 1.

3.0 Tools Supporting Extended Multiplexing

The following lists provide an overview of which tools within the Vector Tool-Chain support Extended Multiplexing.

Tools writing CANdb files:

- CANdb++ (since version 3.0 SP5)
- CANdb++ Admin.J1939 (since version 3.0 SP9)

Tools reading CANdb files:

- CANdb++ (since version 3.0)
- CANalyzer/CANoe.IP
- CANalyzer/CANoe.J1939 (since version 7.0 SP3)
- CANoe.ISO11783 (since version 7.0 SP3)
- CANalyzer/CANoe.CANaerospace (since version 7.2 SP3)
- CANalyzer/CANoe.CANopen (since version 7.2 SP3)

4.0 Extended Multiplexing in CANdb++ and CANdb++ Admin

Using Vector CANdb++ and CANdb++ Admin a DBC database can be created and configured that contains messages and signals. For the remainder of this document, only CANdb++ is mentioned although CANdb++ Admin supports Extended Multiplexing as well.

4.1 Boundary Conditions

Currently extended multiplexing is limited to...

- J1939/NMEA2000/ISO11783 DBC databases (network attribute ProtocolType must contain the value 'J1939', 'NMEA2000' or 'ISO11783')
- CANopen DBC databases (network attribute ProtocolType must contain the value 'CANopen')
- Aerospace DBC databases (network attribute ProtocolType must contain the value 'Aerospace')
- Ethernet DBC databases (network attribute BusType must contain the value 'Ethernet').

To disable extended multiplexing for new DBC databases please open the "settings" dialog of CANdb++ and switch to the **Edit** tab. Now, ensure the **Enable extended multiplexing** checkbox is unchecked (see Fig. 5)

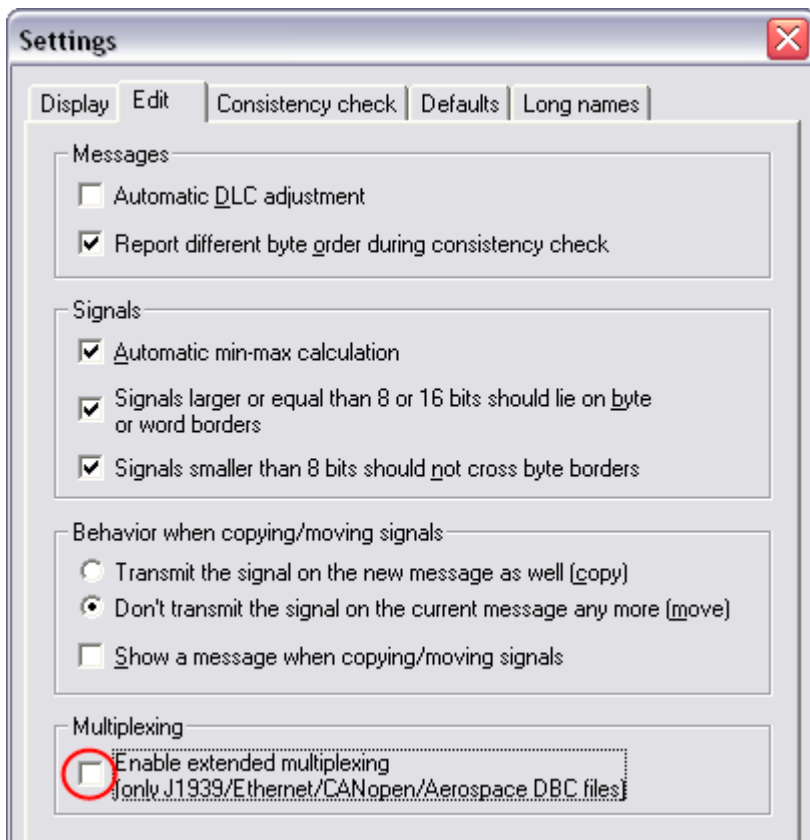

Figure 5 – Settings dialog with extended multiplexing disabled

4.2 Set Up for Extended Signal Multiplexing

First, a message and at least three (preferably more) signals should be created. *There are many ways to assign a signal to a message using CANdb++, but for this example the “drag ‘n’ drop” method will be described.* Dragging the signals onto the message will assign the signals to the message. After selecting the message, the assigned message signals will be visible in the message signal table. Double clicking a message signal, right-clicking the signal name and selecting **Edit Mapped Signal...**, or by using the command **Edit | Edit...** for the selected message signal opens the **Message Signal Dialog**.

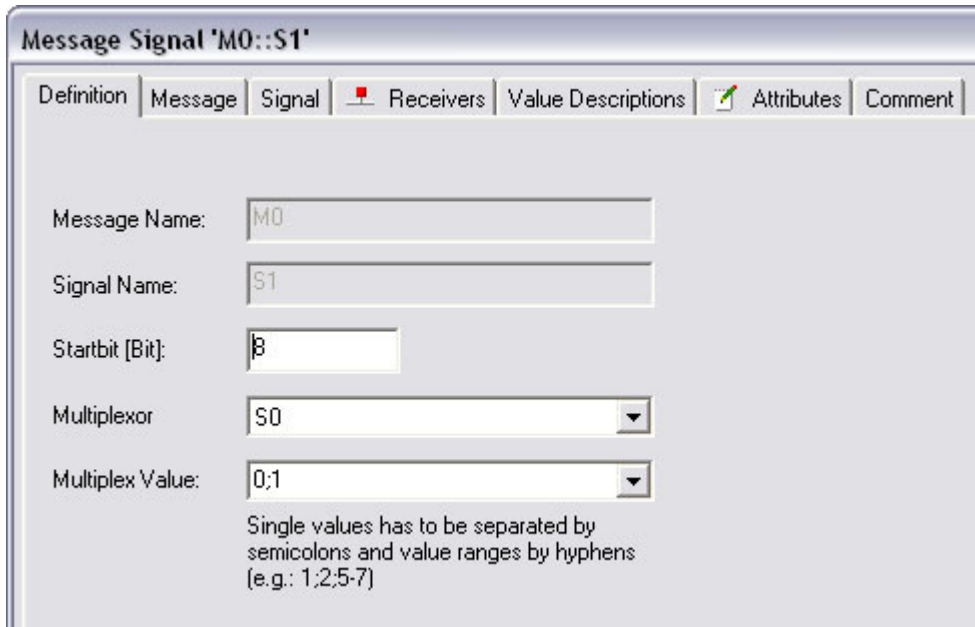

Figure 6 – Message Signal Dialog (as displayed, message signal S1 is valid if message signal S0 is chosen as the multiplexor and has value 0 or 1)

In the Multiplexor field of this dialog, select the signal to act as the multiplexor. Individual values or value ranges can be entered in the Multiplex Value field. If multiple individual values are to be used, indicate this by separating them using a semicolon (value ranges are defined with a hyphen).

In the **Message Signal Table** there is a column **Multiplexing/Group** where the multiplexing information can be found.

Name	Message	Multiplexing/Group	Startbit
S0	M0	Multiplexor	0
S1	M0	S0 = 0;1 Multiplexor	8
S6	M0	S0 = 2	8
S2	M0	S1 = 4	32
S4	M0	S1 = 5	32
S5	M0	S1 = 6	32
S3	M0	S1 = 4	48

Figure 7 – Message Signal Table with multiplexing information

By opening the Message Dialog (double click the message) it is possible to check if the multiplexing information is correct or to shift message signals to other positions. On the **Layout** tab the layout of the message signals within the message is displayed.

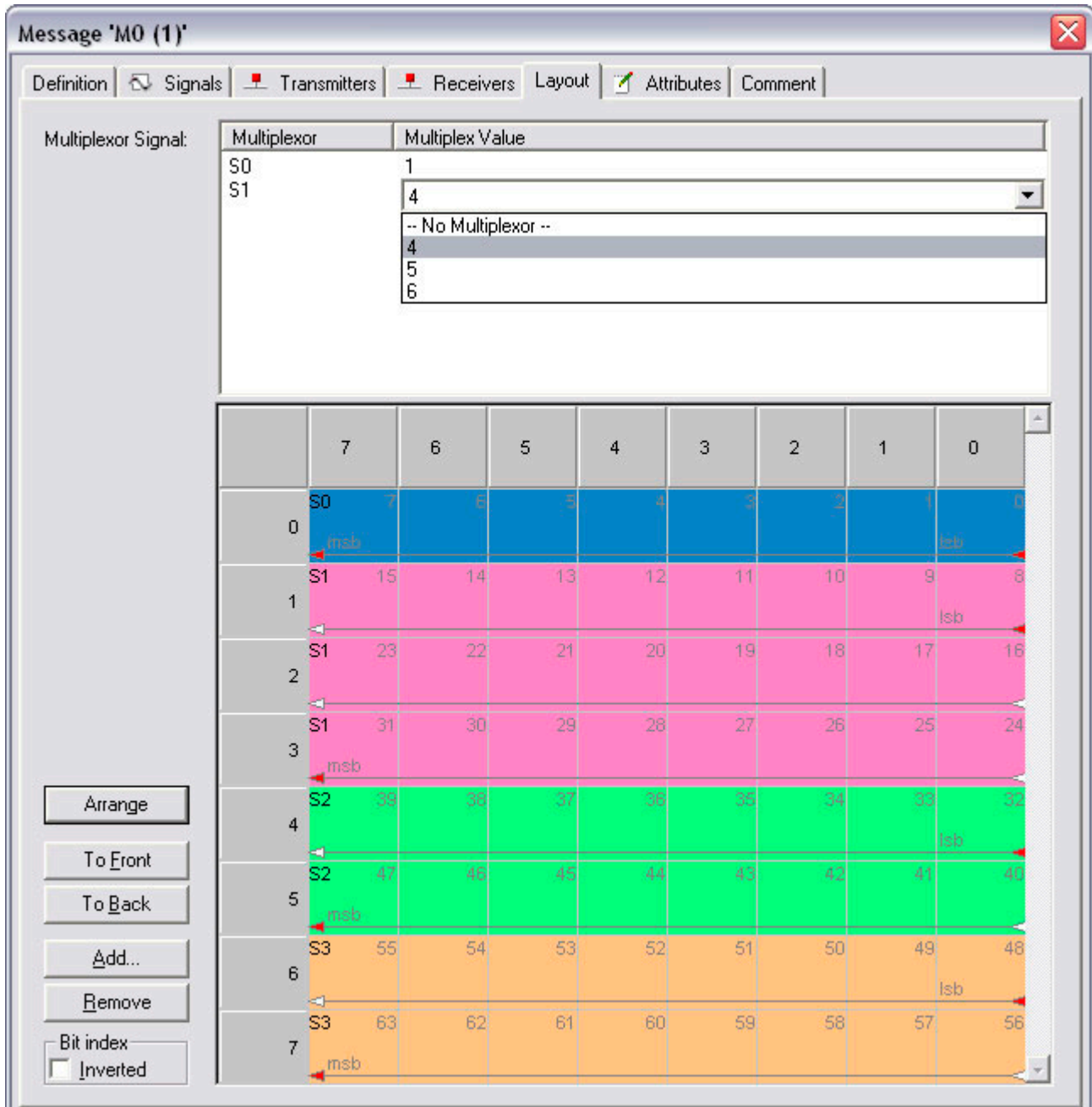

Figure 8 – Layout of the message signals in the Message Dialog

A single click on a multiplexor signal in the **Multiplexor Signal** section selects the multiplexor. A second click opens a combo box/edit field where one of the defined multiplex values may be chosen. Depending on the chosen value the valid message signal combinations will be displayed.

5.0 Extended Multiplexing in CANoe and CANalyzer

Vector CANoe and Vector CANalyzer can handle DBC databases with extended multiplexing information.

5.1 Interactive Generator Block

In the Interactive Generator block's configuration dialog messages are placed in a transmit list and their contents and trigger conditions are defined. A signal list is assigned to each message in which signal values can be configured. Multiplexor signals appear in light green; multiplexed signals in dark green. Depending on the multiplexor values the currently valid signals are displayed.

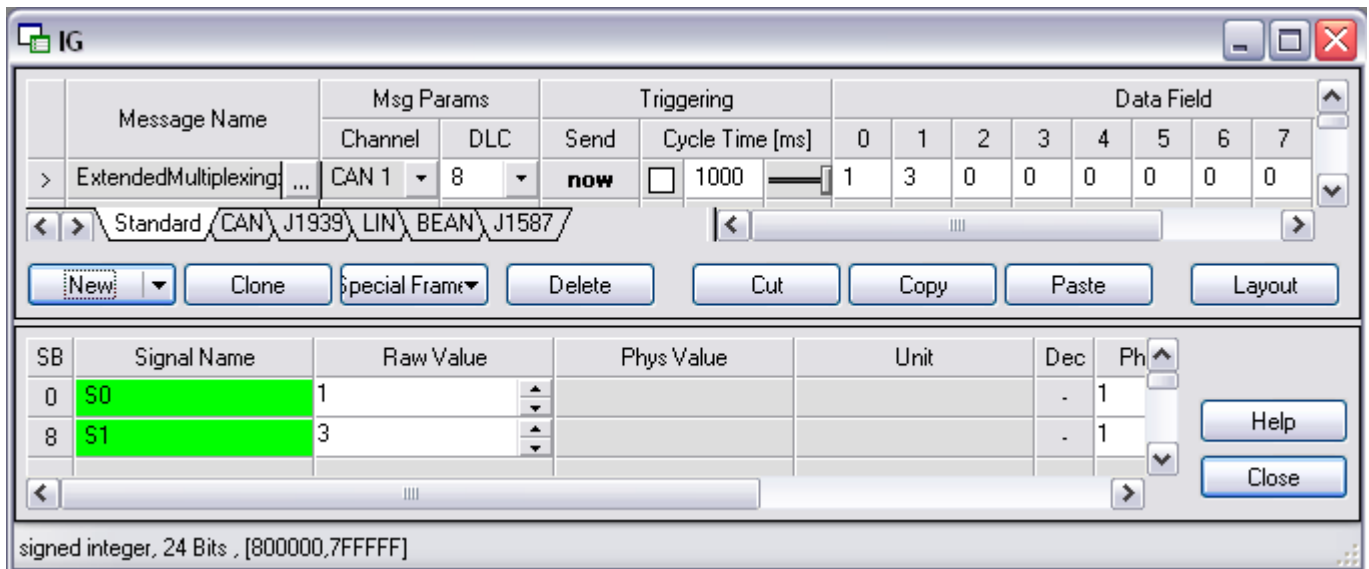

Figure 9 – Interactive Generator Block with multiplexed message signals

If a multiplexor value is changed, the associated multiplexed signals are automatically updated.

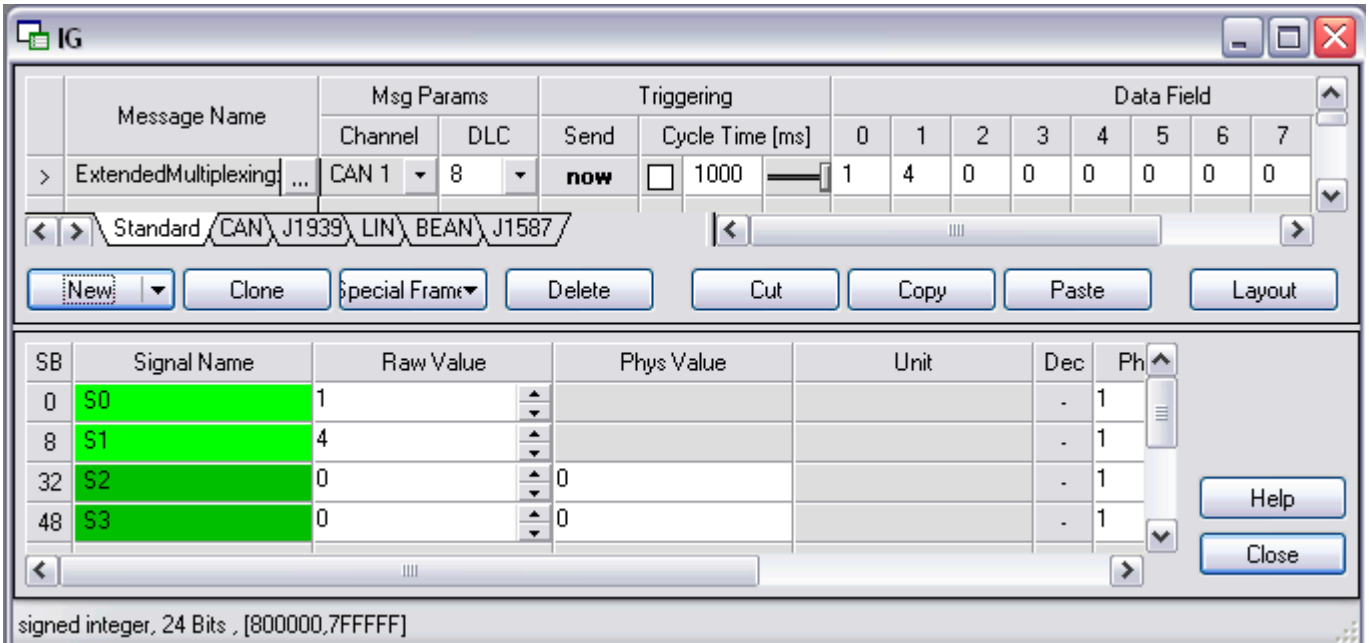

Figure 10 – Value of multiplexor signal S1 is incremented to 4

5.2 Trace Window

Depending on the transferred multiplexor values only the valid message signals are visible in the Trace Window.

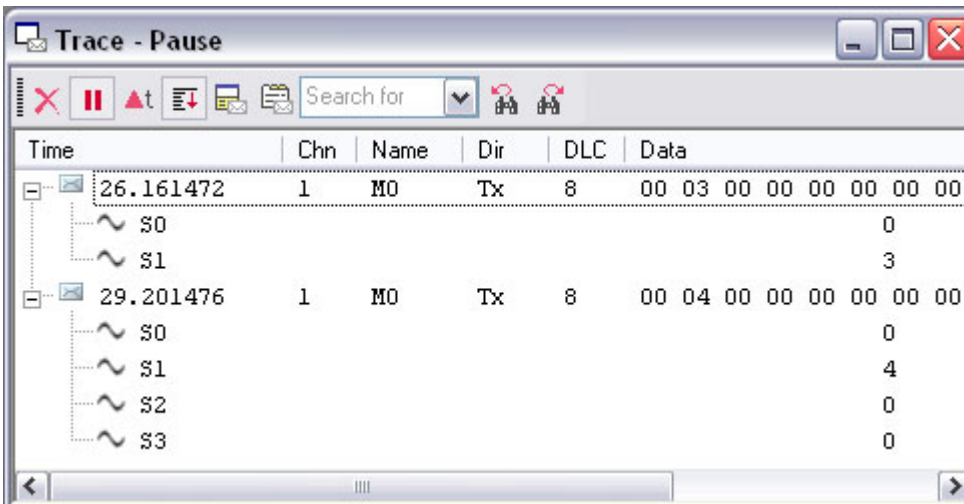
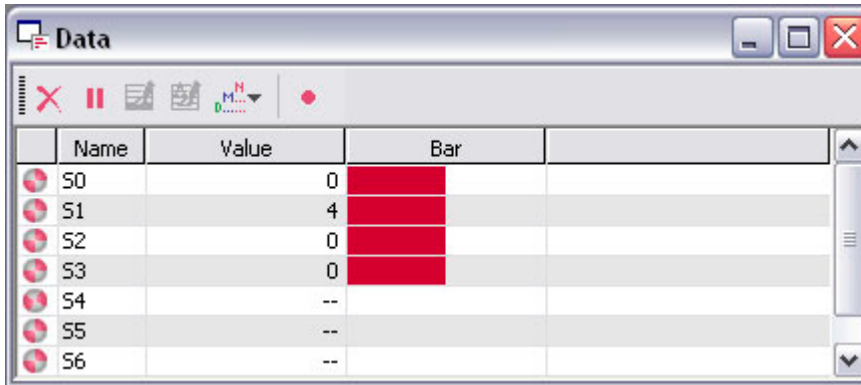

Figure 11 – Trace Window displaying only valid signals

5.3 Data Window

The status column indicates the currently valid message signals.



	Name	Value	Bar
●	S0	0	■
●	S1	4	■
●	S2	0	■
●	S3	0	■
●	S4	--	
●	S5	--	
●	S6	--	

Figure 12 – The activity display in the first column rotates, if the associated message signal is valid

6.0 Additional resources

The following material may provide additional useful information:

VECTOR APPLICATION NOTES

AN-AND-1-116 CANdb++ Tutorial

7.0 Contacts

**Germany
and all countries not named below:**

Vector Informatik GmbH
Ingersheimer Str. 24
70499 Stuttgart
GERMANY
Phone: +49 711-80670-0
Fax: +49 711-80670-111
E-mail: info@de.vector.com

France, Belgium, Luxemburg:

Vector France SAS
168 Boulevard Camélinat
92240 Malakoff
FRANCE
Phone: +33 1 42 31 40 00
Fax: +33 1 42 31 40 09
E-mail: information@fr.vector.com

**Sweden, Denmark, Norway,
Finland, Iceland:**

VecScan AB
Theres Svenssons Gata 9
41755 Göteborg
SWEDEN
Phone: +46 31 764 76 00
Fax: +46 31 764 76 19
E-mail: info@se.vector.com

United Kingdom, Ireland:

Vector GB Ltd.
Rhodium
Central Boulevard
Blythe Valley Park
Solithull, Birmingham
West Midlands B90 8AS
UNITED KINGDOM
Phone: +44 121 50681-50
E-mail: info@uk.vector.com

China:

Vector Informatik GmbH
Shanghai Representative Office
Suite 605, Tower C,
Everbright Convention Center
No. 70 Caobao Road
Xuhui District
Shanghai 200235
P.R. CHINA
Phone: +86 21 - 6432 5353 ext. 0
Fax: +86 21 - 6432 5308
E-mail: info@vector-china.com

India:

Vector Informatik India Private Ltd.
4/1/1/1 Sutar Icon
Sus Road
Pashan
Pune 411021
INDIA
Phone: +91 9673 336575
E-mail: info@vector-india.com

USA, Canada, Mexico:

Vector CANtech, Inc.
39500 Orchard Hill Pl., Ste 550
Novi, MI 48375
USA
Phone: +1 248 449 9290
Fax: +1 248 449 9704
E-mail: info@us.vector.com

Japan:

Vector Japan Co. Ltd.
Seafort Square Center Bld. 18F
2-3-12, Higashi-shinagawa,
Shinagawa-ku
Tokyo 140-0002
JAPAN
Phone: +81 3 5769 7800
Fax: +81 3 5769 6975
E-mail: info@jp.vector.com

Korea:

Vector Korea IT Inc.
#1406, Mario Tower,
222-12 Guro-dong, Guro-gu
Seoul, 152-848
REPUBLIC OF KOREA
Phone: +82 2 807 0600
Fax: +82 2 807 0601
E-mail: info@kr.vector.com
